

Basic Pump

DS

Self Priming Centrifugal Pump

Model T3A3S-B

Size 3" x 3"

Super
TSERIES

VARIOUS PATENTS APPLY



PUMP SPECIFICATIONS

Size: 3" x 3" (76 mm x 76 mm) NPT - Female.**Casing:** Gray Iron 30.

Maximum Operating Pressure 86 psi (593 kPa).*

Semi-Open Type, Two Vane Impeller: Ductile Iron 65-45-12.

Handles 2 1/2" (63,5 mm) Diameter Spherical Solids.

Impeller Shaft: Alloy Steel 4150.**Shaft Sleeve:** Alloy Steel 4130.**Replaceable Wear Plate:** Carbon Steel 1015.**Removable Adjustable Cover Plate:** Gray Iron 30; 35 lbs. (16 kg)**Seal Plate:** Gray Iron 30.**Flap Valve:** Neoprene ^{w/}Nylon and Steel Reinforcing.**Bearing Housing:** Gray Iron 30.**Radial and Thrust Bearings:** Open Single Row Ball.**Bearing and Seal Cavity Lubrication:** SAE 30 Non-Detergent Oil.**Flanges:** Gray Iron 30.**Gaskets:** Buna-N ^{w/}Compressed Synthetic Fibers, Vegetable Fiber, PTFE, Cork and Rubber.**O-Rings:** Buna-N.**Hardware:** Standard Plated Steel.**Brass Pressure Relief Valve.****Bearing and Seal Cavity Oil Level Sight Gauges.****Optional Equipment:** Automatic Air Release Valve. Metal

Bellows Seal. 120V/240V Casing Heater. High Pump

Temperature Shutdown Kit. G-R Hard Iron Casing.

Self-Cleaning Wear Plate.

Gray Iron 30 Suction and Discharge Spool Flanges:

3" ASA (**Specify Model T3A3S-B /F**).80 mm DIN 2527 (PN 16) (**Specify Model T3A3S-B /FM**).***Consult Factory for Applications Exceeding Maximum Pressure and/or Temperature Indicated.**

Shown with Optional Suction and Discharge Spool Flanges (Available in ASA or DIN Standard Sizes).

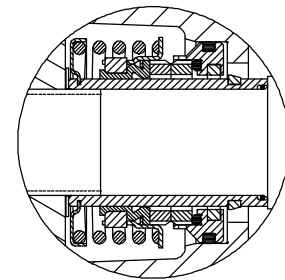
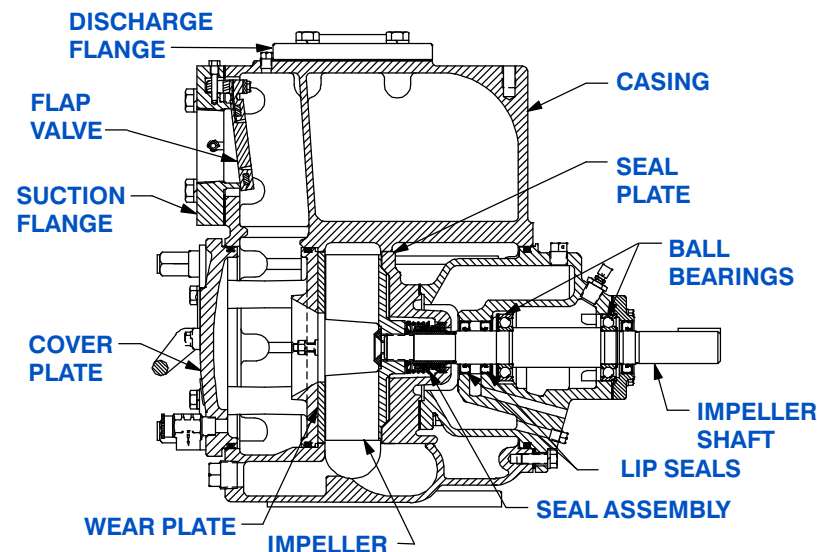

SEAL DETAIL

Cartridge Type, Mechanical, Oil-Lubricated, Double Floating, Self-Aligning. Tungsten Titanium Carbide Rotating and Stationary Faces. Stainless Steel 316 Stationary Seat. Fluorocarbon Elastomers (DuPont Viton[®] or Equivalent). Stainless Steel 18-8 Cage and Spring. Maximum Temperature of Liquid Pumped, 160°F (71°C).*



THE GORMAN-RUPP COMPANY • MANSFIELD, OHIO

GORMAN-RUPP OF CANADA LIMITED • ST. THOMAS, ONTARIO, CANADA

www.grpumps.com

Specifications Subject to Change Without Notice

Printed in U.S.A.

Specification Data

SECTION 55, PAGE 2000

APPROXIMATE DIMENSIONS and WEIGHTS

NET WEIGHT: 404 LBS. (183 KG.)*
SHIPPING WEIGHT: 452 LBS. (205 KG.)*
EXPORT CRATE: 19.3 CU. FT. (0,55 CU. M.)
***ADD 10 LBS. (4,5 KG.) W/EACH SPOOL FLANGE**

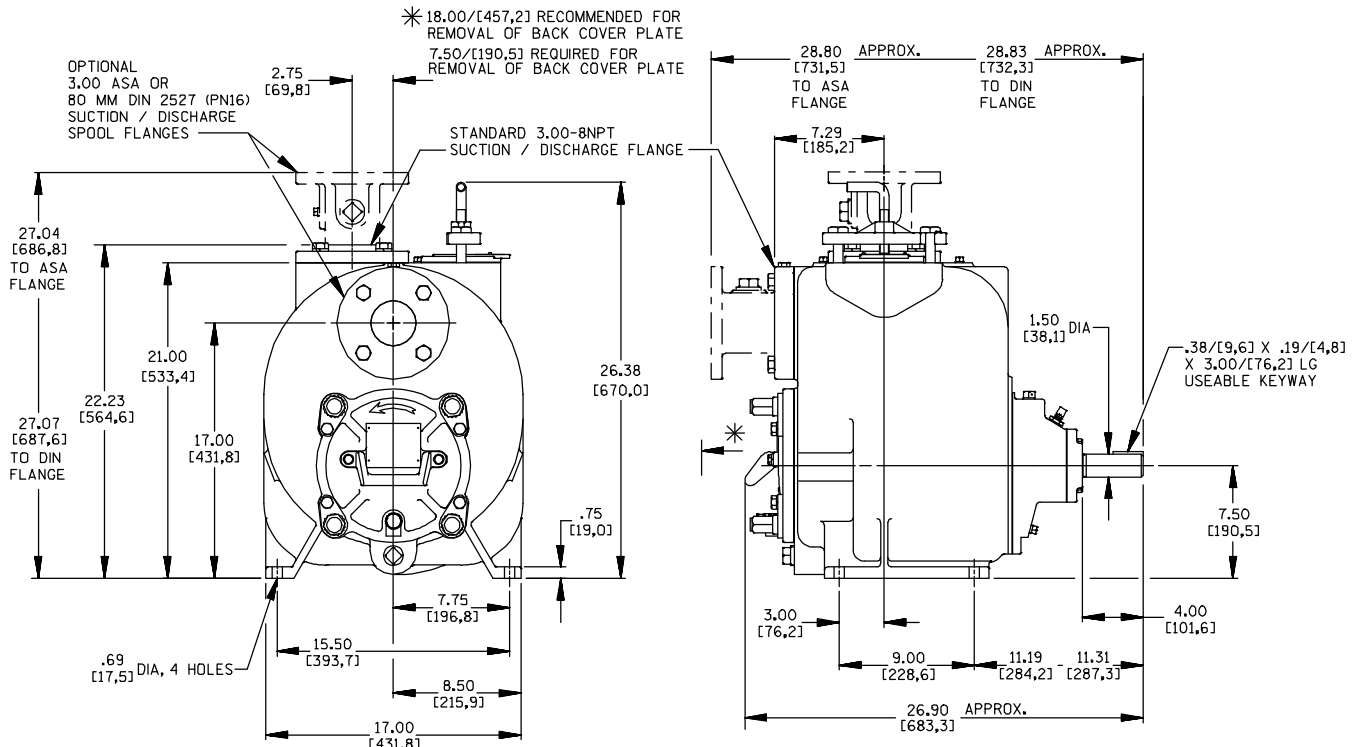

OPTIONAL ASA OR DIN STANDARD SUCTION & DISCHARGE SPOOL FLANGES AVAILABLE

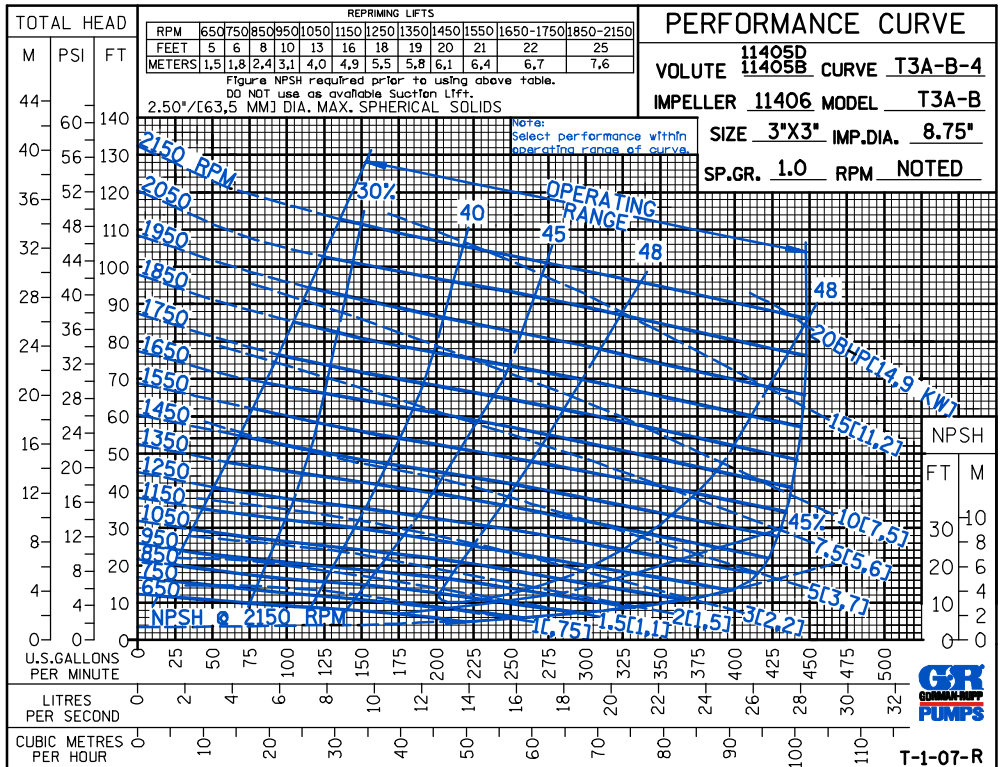

THE GORMAN-RUPP COMPANY • MANSFIELD, OHIO

GORMAN-RUPP OF CANADA LIMITED • ST. THOMAS, ONTARIO, CANADA

Specifications Subject to Change Without Notice

Printed in U.S.A.

CDS

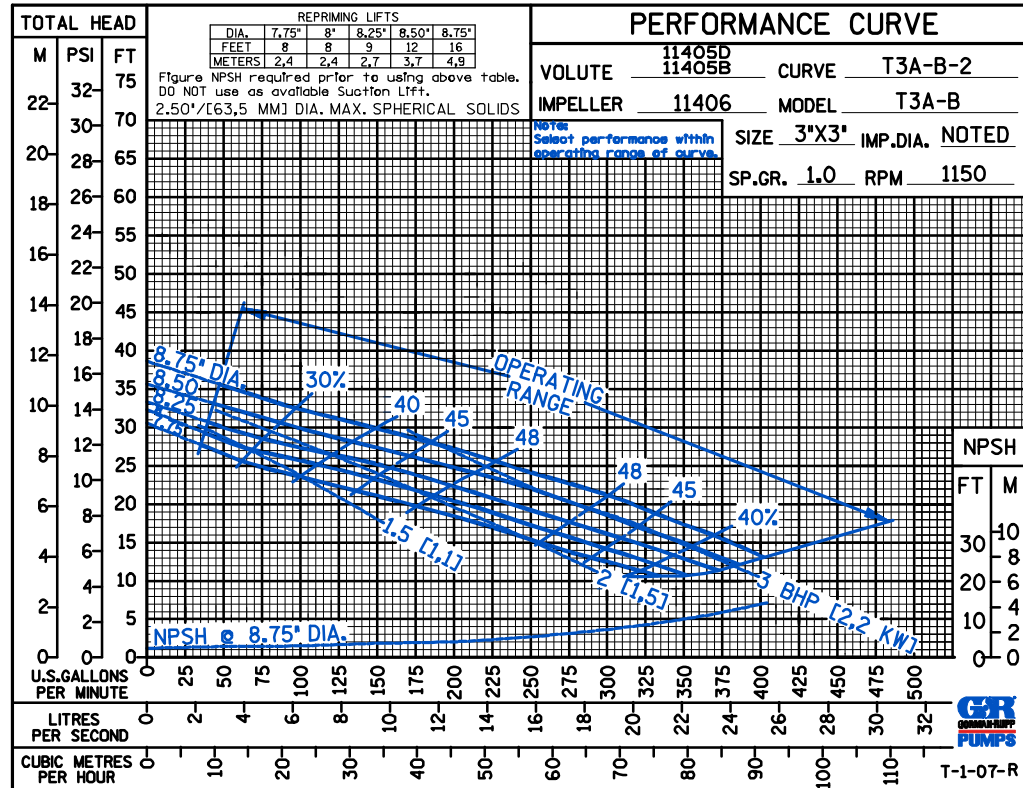
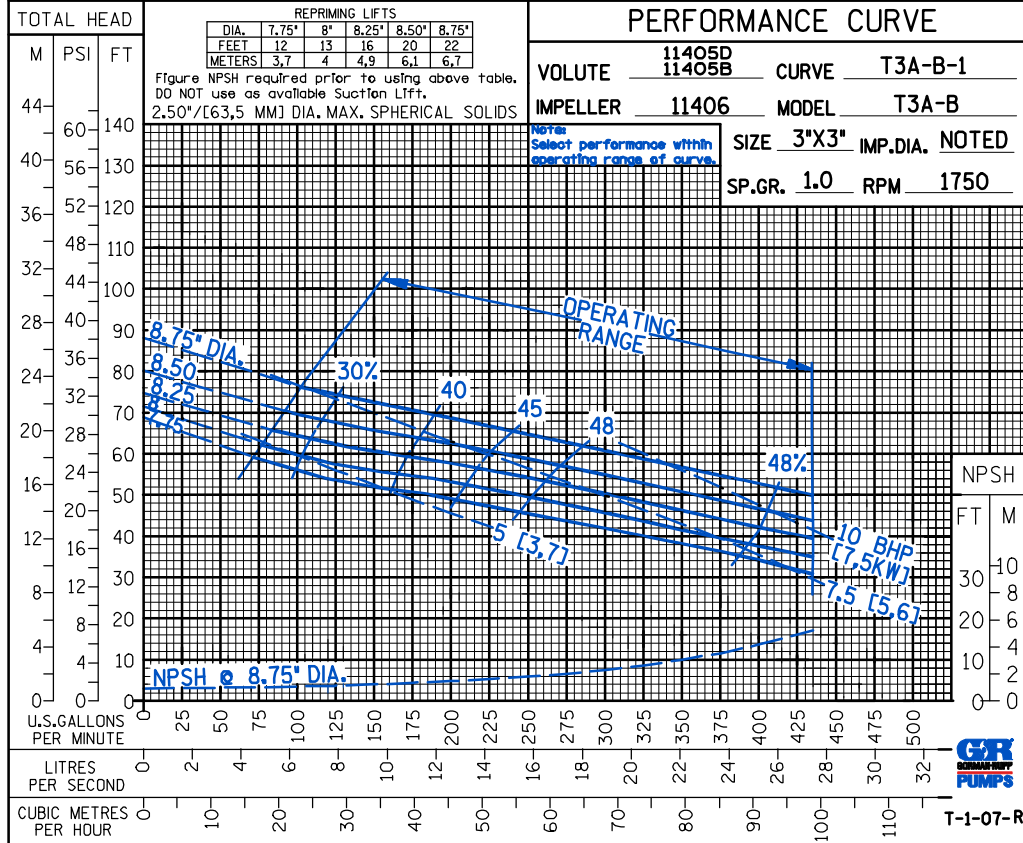

THE GORMAN-RUPP COMPANY • MANSFIELD, OHIO

GORMAN-RUPP OF CANADA LIMITED • ST. THOMAS, ONTARIO, CANADA

Specifications Subject to Change Without Notice

Printed in U.S.A.

CDS

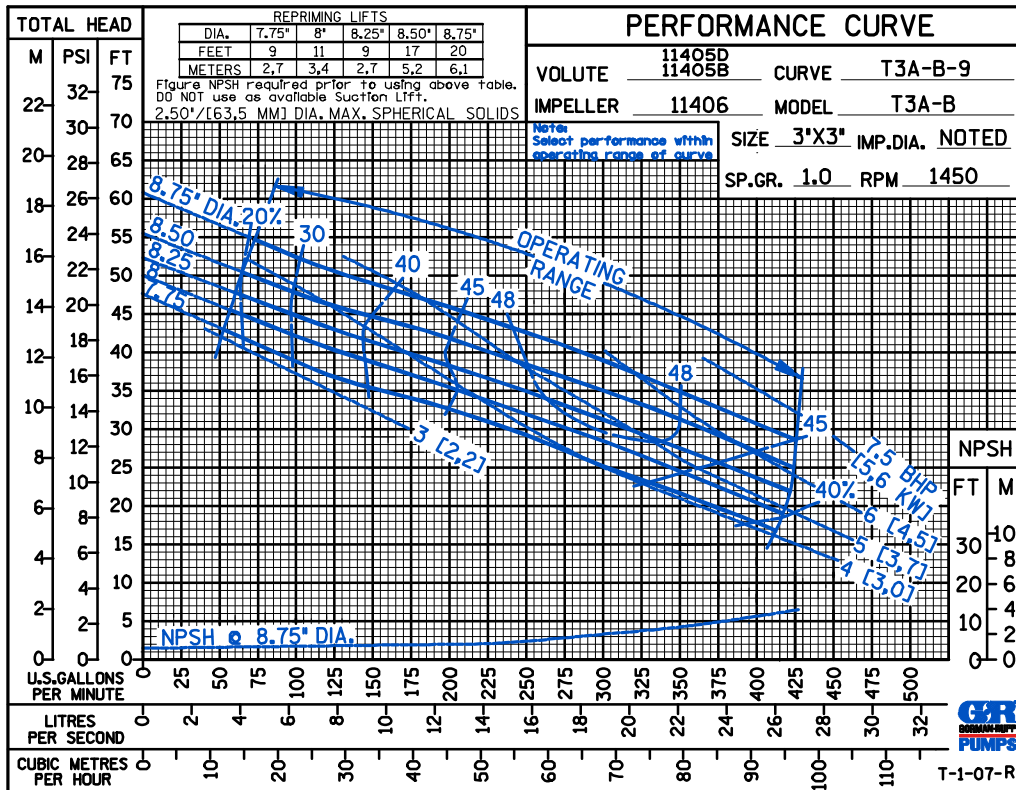
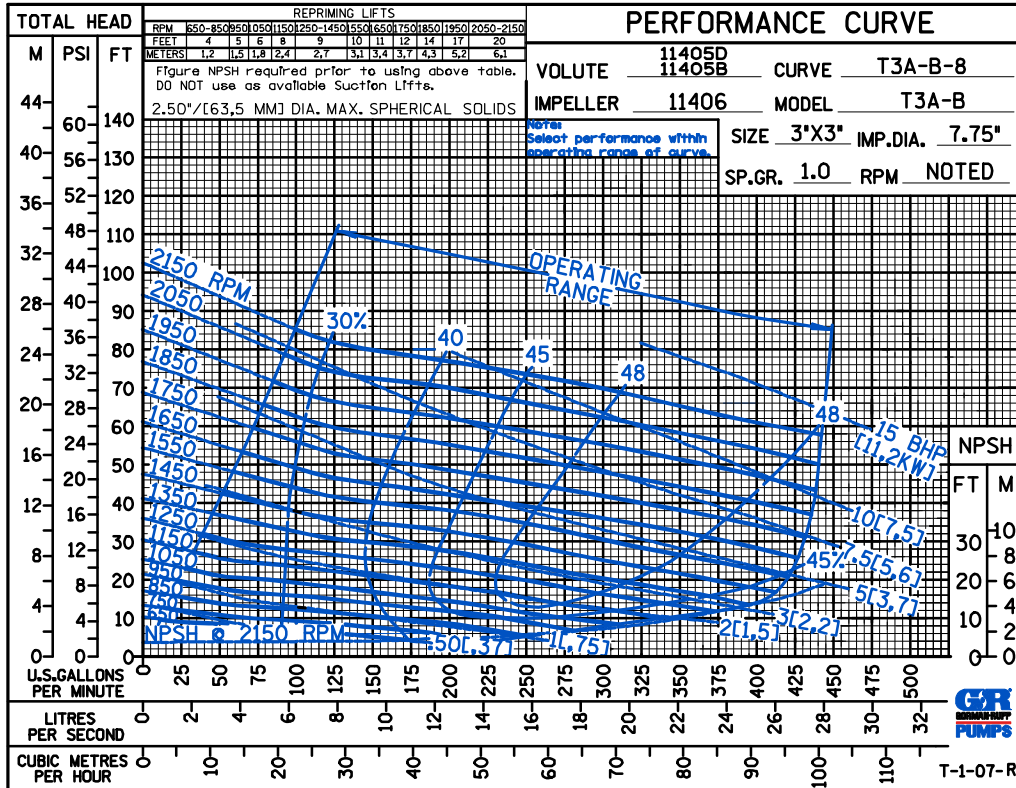

50 HERTZ



THE GORMAN-RUPP COMPANY • MANSFIELD, OHIO

GORMAN-RUPP OF CANADA LIMITED • ST. THOMAS, ONTARIO, CANADA

Specifications Subject to Change Without Notice

Printed in U.S.A.

CDS

50 HERTZ

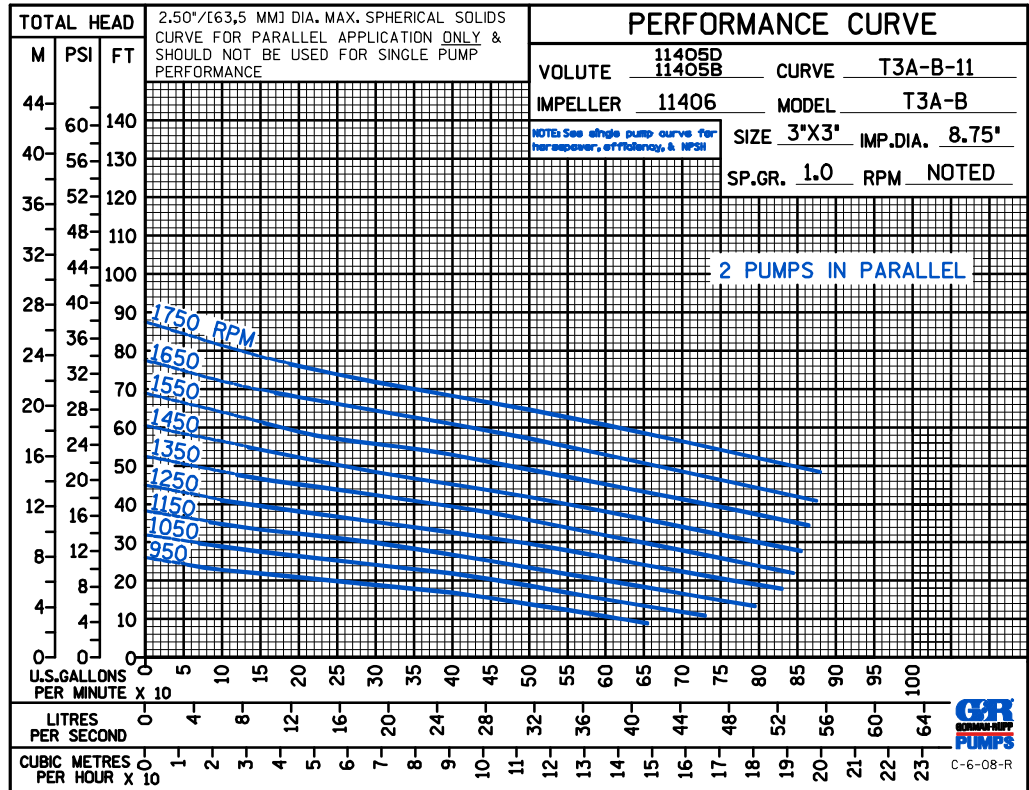
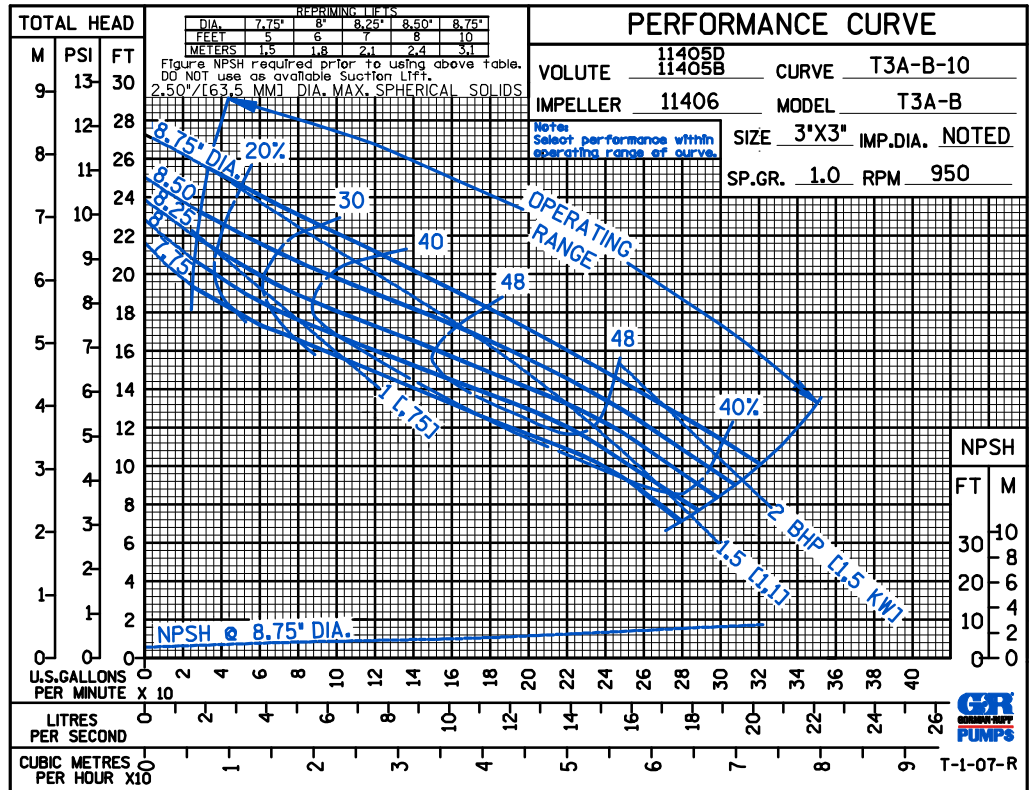

THE GORMAN-RUPP COMPANY • MANSFIELD, OHIO

GORMAN-RUPP OF CANADA LIMITED • ST. THOMAS, ONTARIO, CANADA

Specifications Subject to Change Without Notice

Printed in U.S.A.

CDS

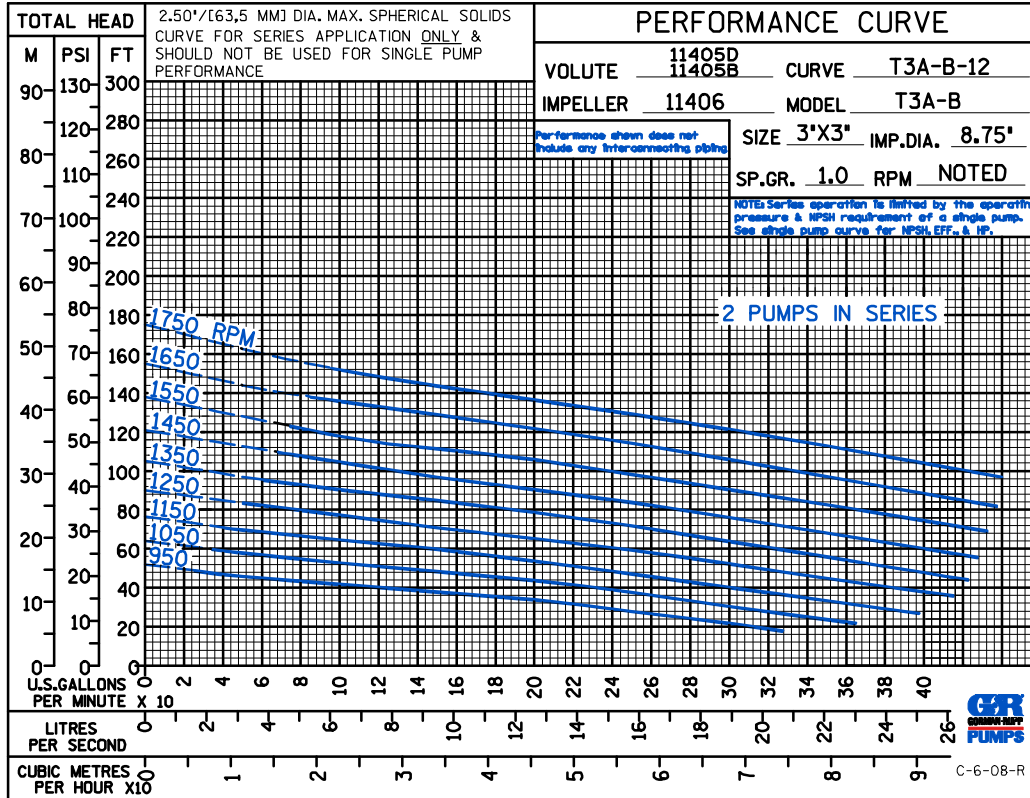

THE GORMAN-RUPP COMPANY • MANSFIELD, OHIO

GORMAN-RUPP OF CANADA LIMITED • ST. THOMAS, ONTARIO, CANADA

Specifications Subject to Change Without Notice

Printed in U.S.A.