

DS

# Self Priming Centrifugal Pump

**Super  
T SERIES**

VARIOUS PATENTS APPLY

**Model T4A3S-B****Size 4" x 4"****PUMP SPECIFICATIONS****Size:** 4" x 4" (101 mm x 101 mm) NPT - Female.**Casing:** Gray Iron 30.

Maximum Operating Pressure 86 psi (593 kPa).\*

**Semi-Open Type, Two Vane Impeller:** Ductile Iron 65-45-12.

Handles 3" (76,2 mm) Diameter Spherical Solids.

**Impeller Shaft:** Alloy Steel 4150.**Shaft Sleeve:** Alloy Steel 4130.**Replaceable Wear Plate:** Carbon Steel ASTM A36.**Removable Adjustable Cover Plate:** Gray Iron 30; 41 lbs. (18 kg).**Flap Valve:** Neoprene w/Nylon and Steel Reinforcing.**Seal Plate:** Gray Iron 30.**Bearing Housing:** Gray Iron 30.**Radial Bearing:** Open Single Row Ball.**Thrust Bearing:** Open Double Row Ball.**Bearing and Seal Cavity Lubrication:** SAE 30 Non-Detergent Oil.**Flanges:** Gray Iron 30.**Gaskets:** Buna-N w/Compressed Synthetic Fibers, Vegetable Fiber, PTFE, Cork, and Rubber.**O-Rings:** Buna-N.**Hardware:** Standard Plated Steel.**Brass Pressure Relief Valve.****Bearing and Seal Cavity Oil Level Sight Gauges.****Optional Equipment:** Automatic Air Release Valve. Metal

Bellows Seal. 120V/240V Casing Heater. High Pump Temperature Shutdown Kit. Self-Cleaning Wear Plate.

Gray Iron 30 Suction and Discharge Spool Flanges:

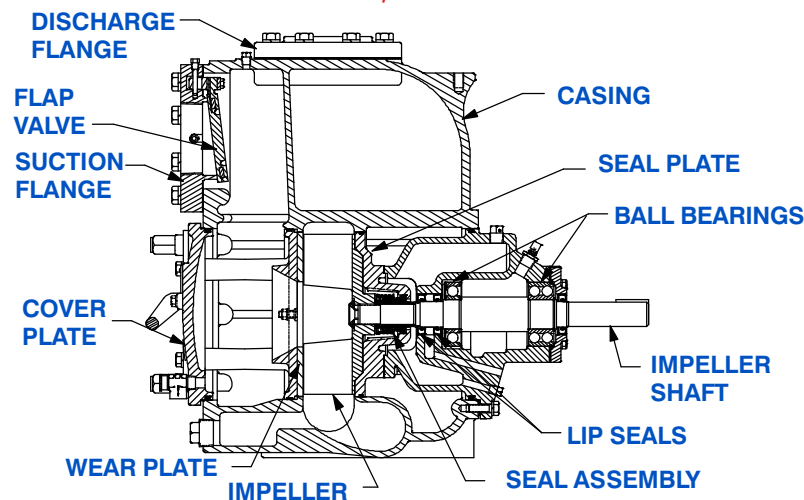
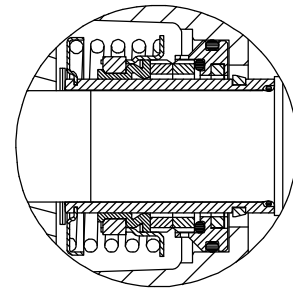
4" ASA (**Specify Model T4A3S-B /F**).100 mm DIN 2527 (PN 16) (**Specify Model T4A3S-B /FM**).*\*Consult Factory for Applications Exceeding Maximum Pressure and/or Temperature Indicated.***Shown with Optional Suction & Discharge Spool Flanges (Available in ASA or DIN Standard Sizes).****SEAL DETAIL**

Cartridge Type, Mechanical, Oil-Lubricated, Double Floating, Self-Aligning. Tungsten Titanium Carbide Rotating and Stationary Faces. Stainless Steel 316 Stationary Seat. Fluorocarbon Elastomers (DuPont Viton® or Equivalent). Stainless Steel 18-8 Cage and Spring. Maximum Temperature of Liquid Pumped, 160°F (71°C).\*

**THE GORMAN-RUPP COMPANY • MANSFIELD, OHIO**

GORMAN-RUPP OF CANADA LIMITED • ST. THOMAS, ONTARIO, CANADA

www.grpumps.com

Specifications Subject to Change Without Notice

Printed in U.S.A.

**Specification Data**

SECTION 55, PAGE 2100

**APPROXIMATE DIMENSIONS and WEIGHTS**

**NET WEIGHT: 575 LBS. (261 KG.)\***  
**SHIPPING WEIGHT: 614 LBS. (279 KG.)\***  
**EXPORT CRATE: 22.7 CU. FT. (0,64 CU. M.)**  
**\*ADD 15 LBS. (6,8 KG.) W/EACH SPOOL FLANGE**

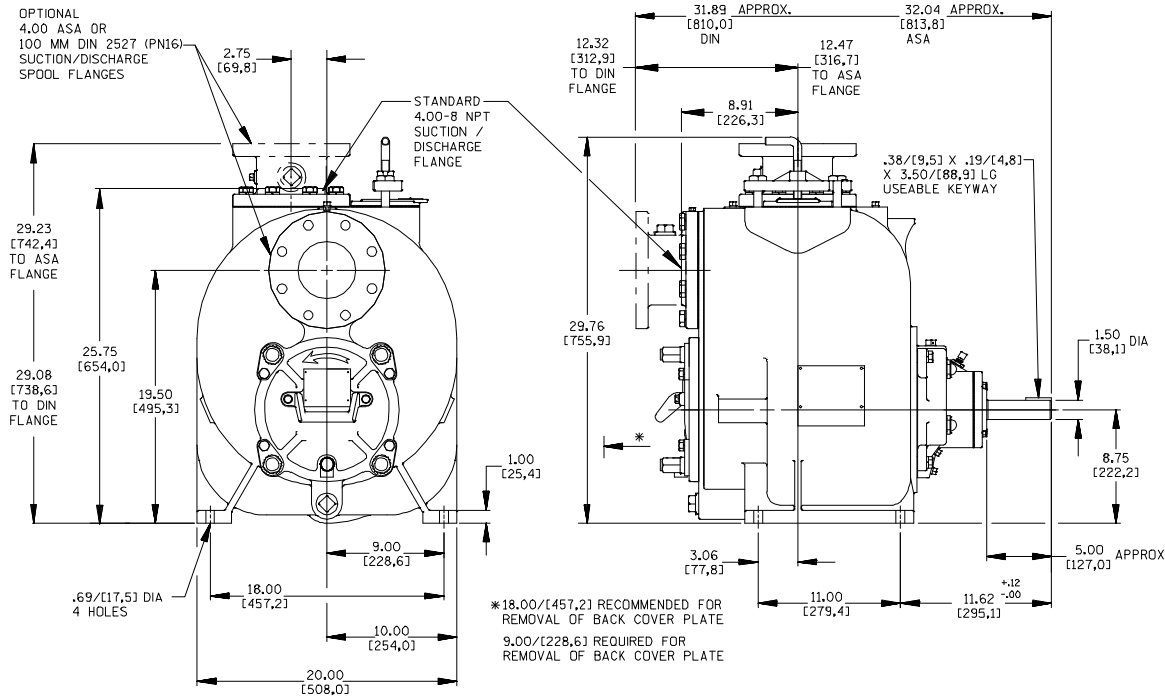

NOTE: OPTIONAL ASA OR DIN STANDARD SUCITON & DISCHARGE SPOOL FLANGES AVAILABLE.

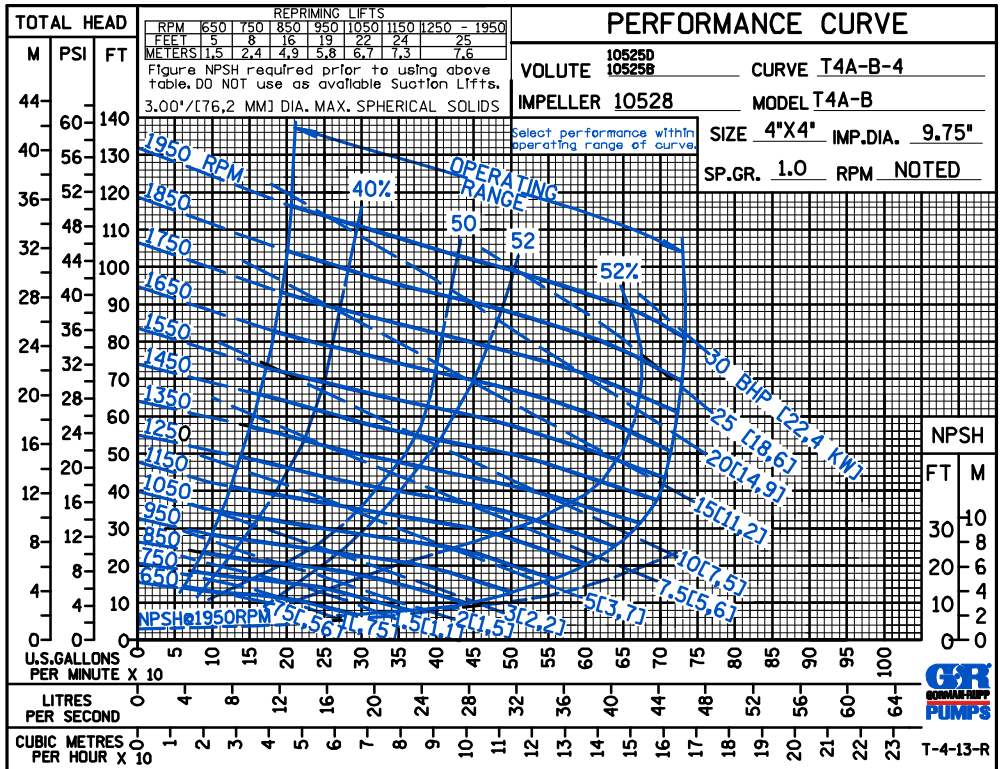

THE GORMAN-RUPP COMPANY • MANSFIELD, OHIO

GORMAN-RUPP OF CANADA LIMITED • ST. THOMAS, ONTARIO, CANADA

Specifications Subject to Change Without Notice

Printed in U.S.A.

CDS

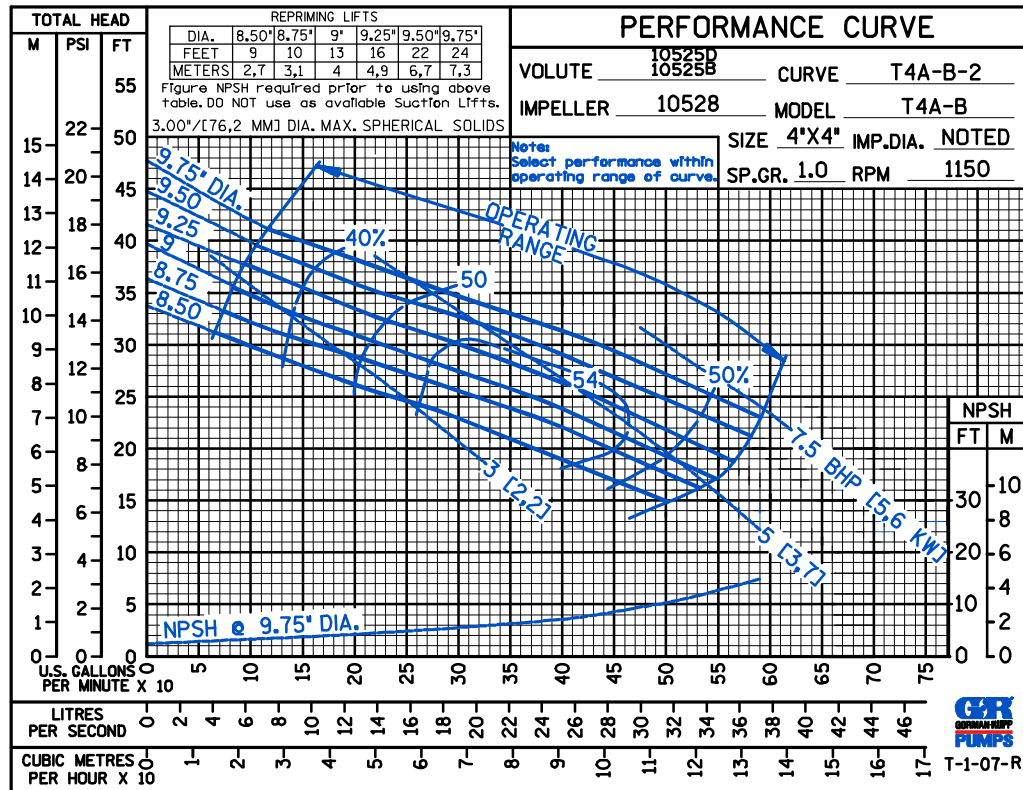
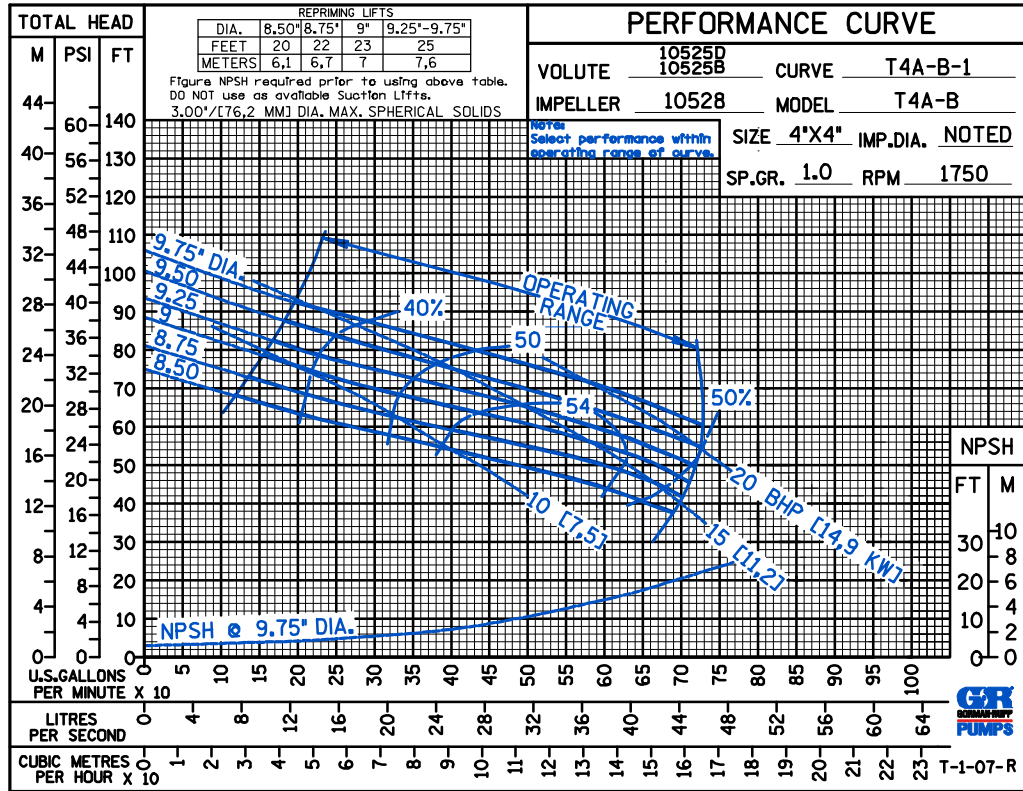

THE GORMAN-RUPP COMPANY • MANSFIELD, OHIO

GORMAN-RUPP OF CANADA LIMITED • ST. THOMAS, ONTARIO, CANADA

Specifications Subject to Change Without Notice

Printed in U.S.A.

CDS

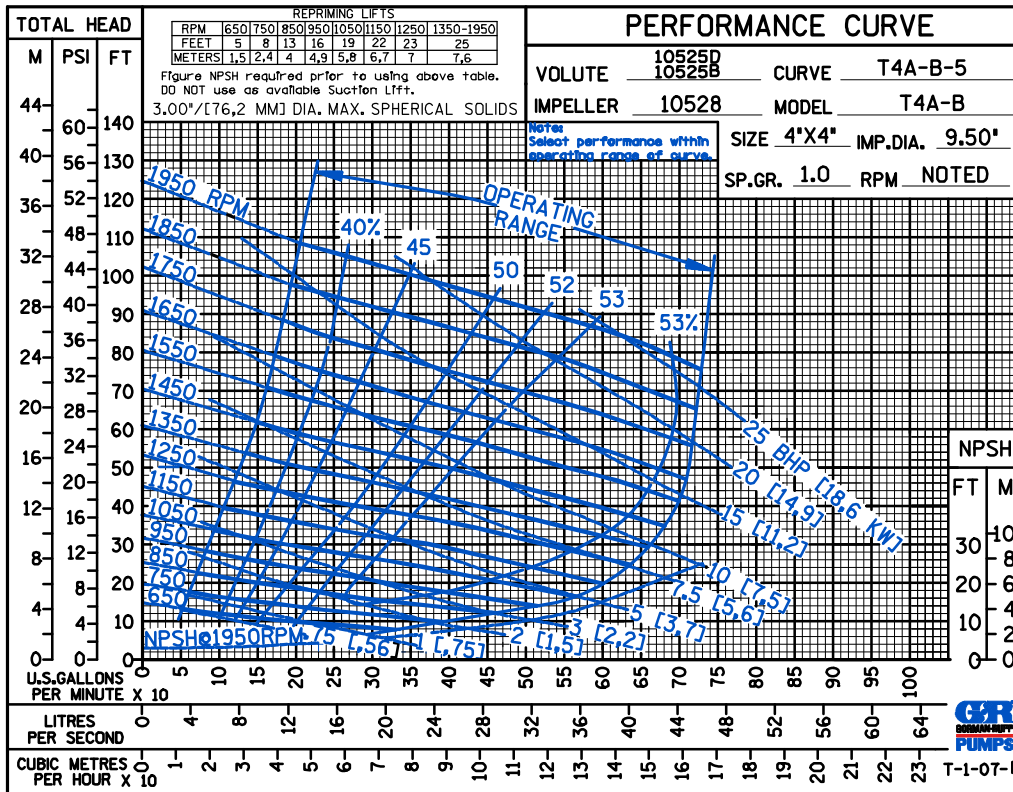
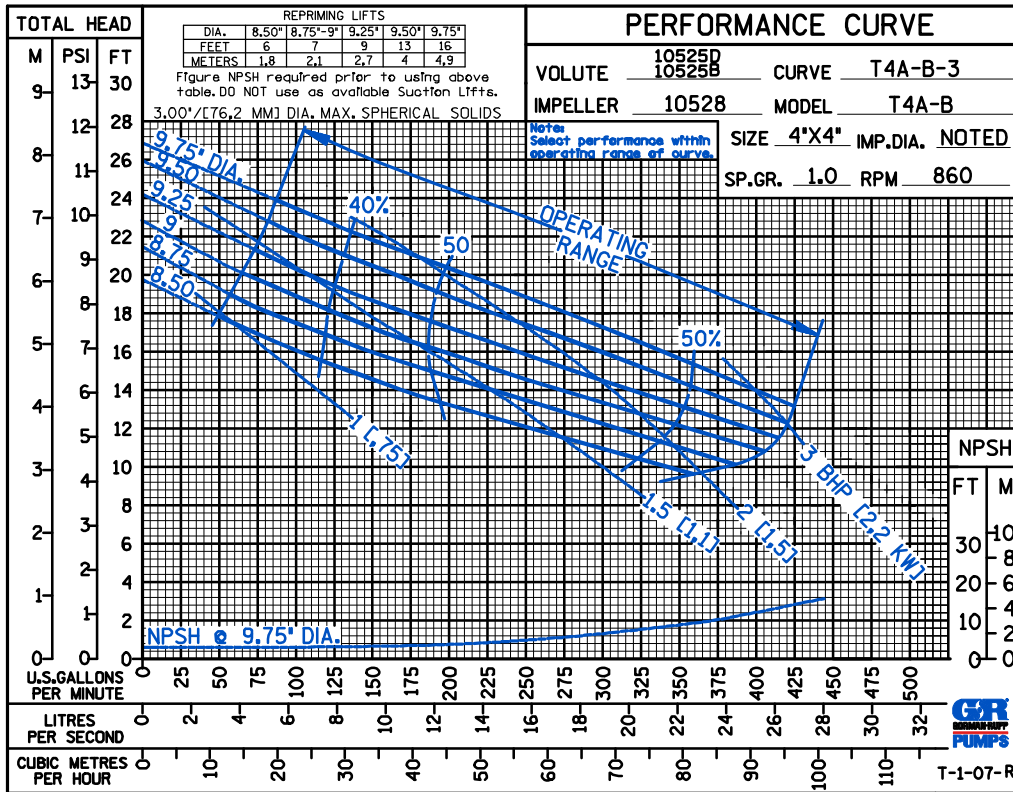

THE GORMAN-RUPP COMPANY • MANSFIELD, OHIO

GORMAN-RUPP OF CANADA LIMITED • ST. THOMAS, ONTARIO, CANADA

Specifications Subject to Change Without Notice

Printed in U.S.A.

CDS

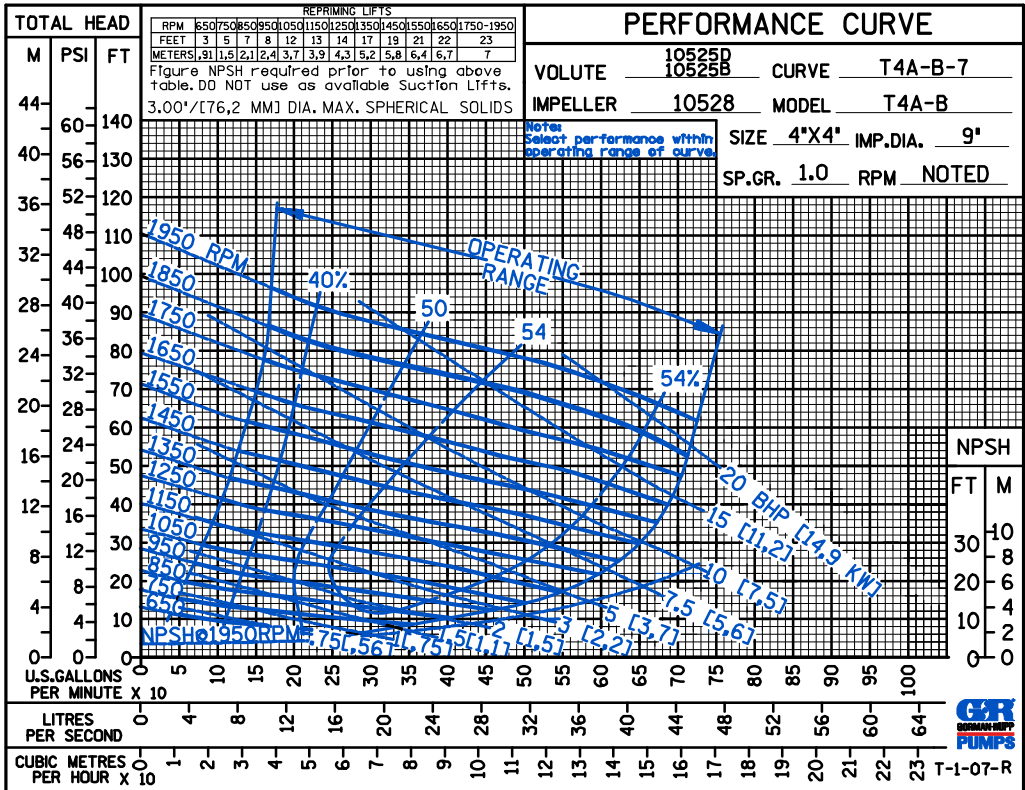
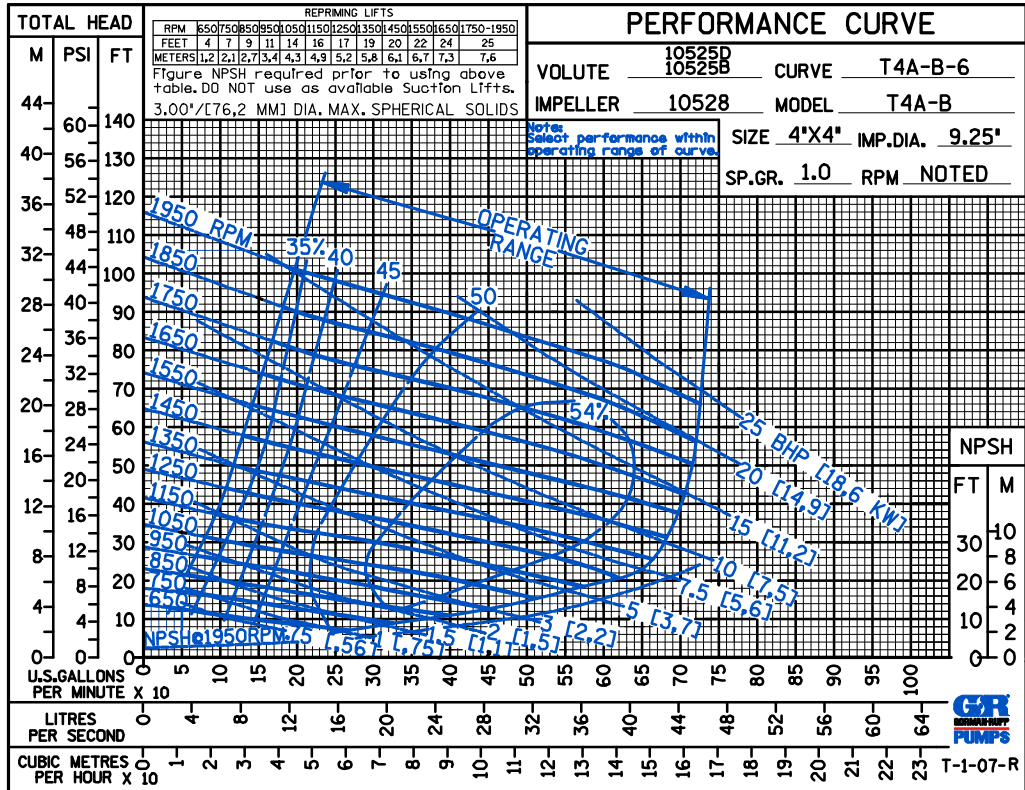

THE GORMAN-RUPP COMPANY • MANSFIELD, OHIO

GORMAN-RUPP OF CANADA LIMITED • ST. THOMAS, ONTARIO, CANADA

Specifications Subject to Change Without Notice

Printed in U.S.A.

CDS

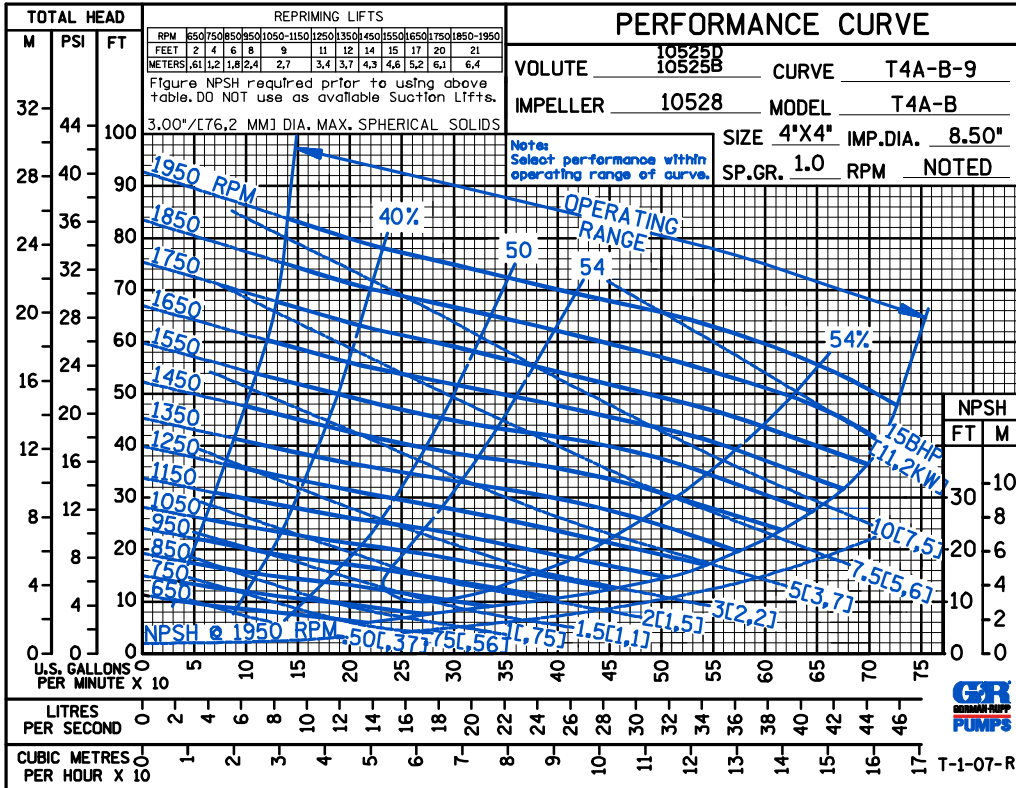
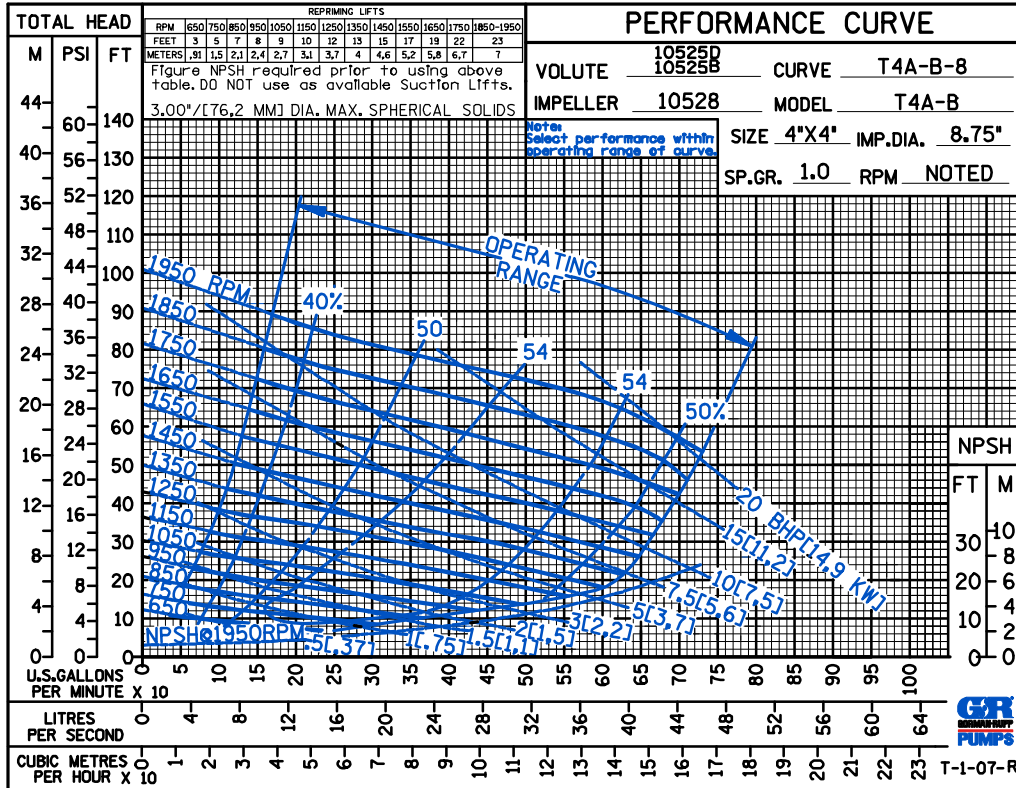

THE GORMAN-RUPP COMPANY • MANSFIELD, OHIO

GORMAN-RUPP OF CANADA LIMITED • ST. THOMAS, ONTARIO, CANADA

Specifications Subject to Change Without Notice

Printed in U.S.A.

CDS

50 HERTZ

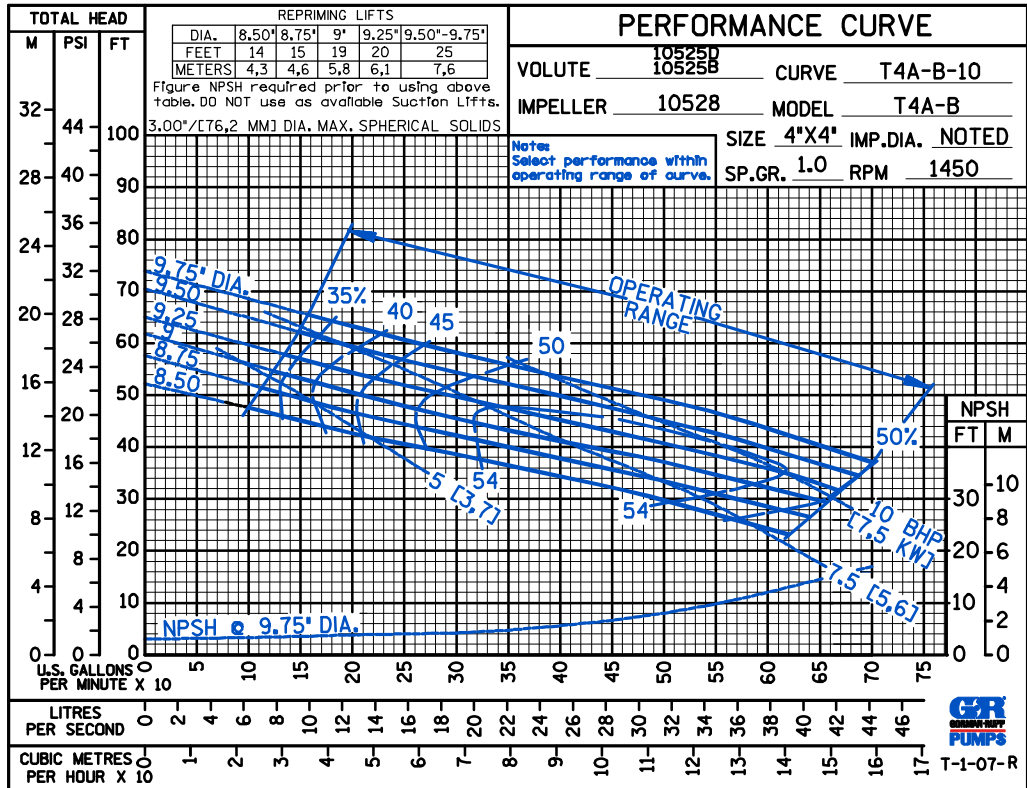

50 HERTZ

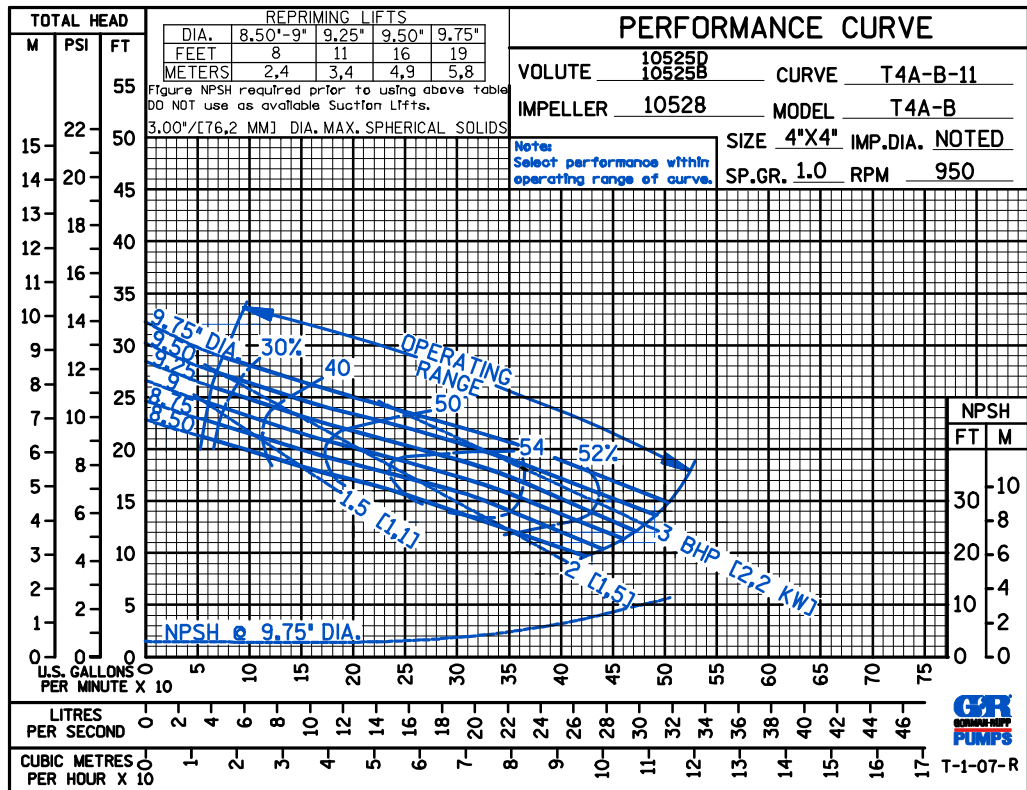

THE GORMAN-RUPP COMPANY • MANSFIELD, OHIO

GORMAN-RUPP OF CANADA LIMITED • ST. THOMAS, ONTARIO, CANADA

Specifications Subject to Change Without Notice

Printed in U.S.A.

D S

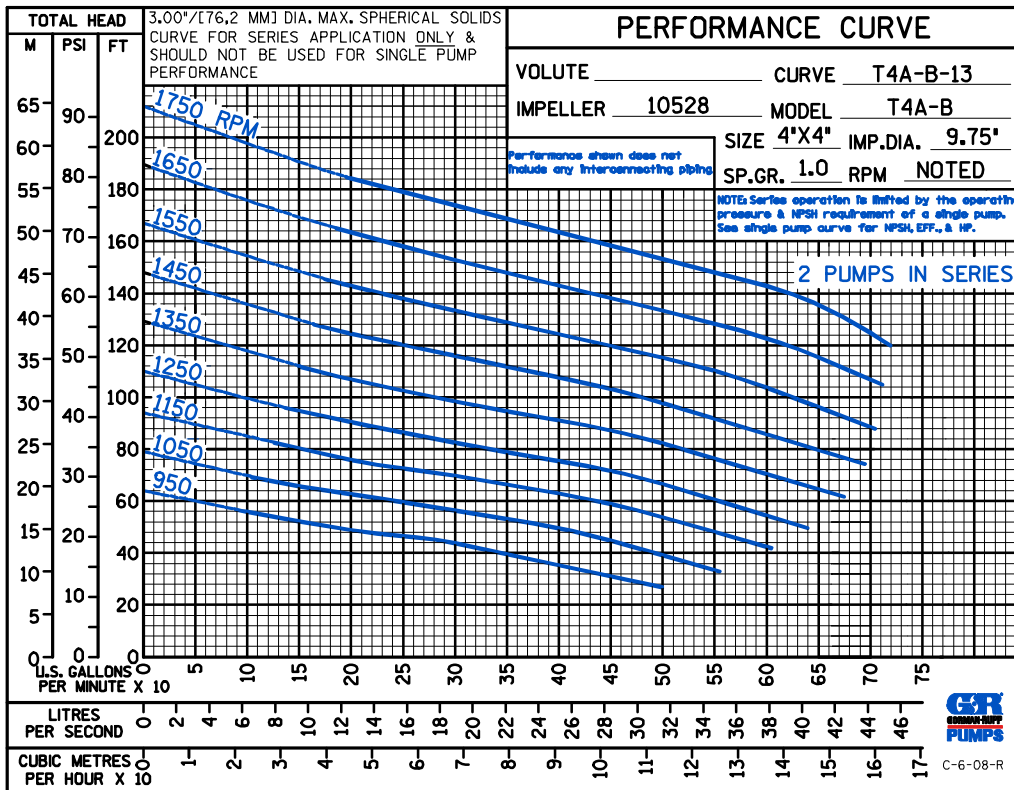
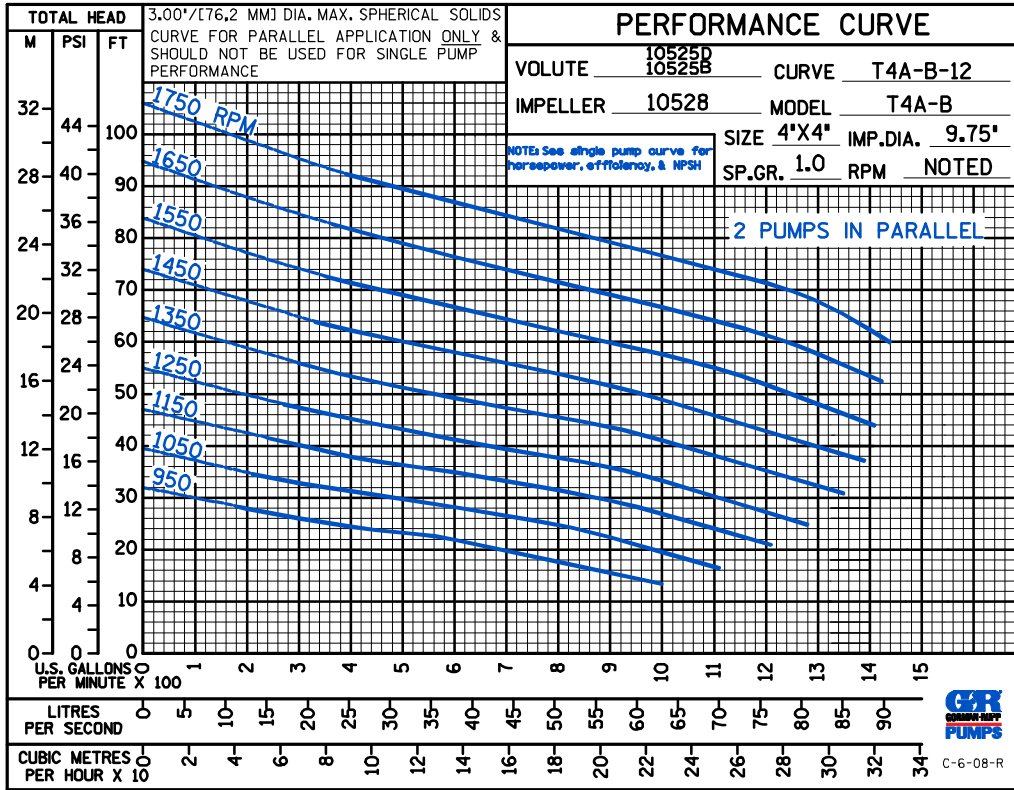

THE GORMAN-RUPP COMPANY • MANSFIELD, OHIO

GORMAN-RUPP OF CANADA LIMITED • ST. THOMAS, ONTARIO, CANADA

Specifications Subject to Change Without Notice

Printed in U.S.A.